

HENRIKSEN HOOKS

**HOOKS**  
HENRIKSEN HOOKS

**HMKG**

OFF-LOAD RELEASE MANUAL HOOKS



U  
S  
E  
R  
  
M  
A  
N  
U  
A  
L

Rev.: -1

M000133

**HENRIKSEN**

REDUCING OPERATIONAL RISK

Phone: +47 33 37 84 00  
hooks@hhenriksen.com  
www.henriksenhooks.com

## GENERAL

- Read this user manual carefully before you use the hook and save it for future reference.
- Operational scenarios with corresponding risk evaluations must be well known for the operators.
- It is important that the hook is inspected and maintained periodically to ensure a safe and well-functioning equipment.
- Monthly controls by the operators are limited to visual check and practical operations.
- All necessary service and maintenance shall be carried out by authorized service personal annually and by 5-years controls. On-line annual inspection course for Henriksen hooks is available on the internet, please check our website for more information.
- Contact the manufacturer in case of any visible damage and/or if malfunction occurs.
- Any unauthorized repair, service and/or parts used in the hook will violate the warranty.

## HMKG

### LAUNCH

- 1** Check visually the following before launch:
- the hook is not damaged
  - the hook element is in closed position
  - the handle is in the low (closed) position
  - the safety pin is properly placed, refer to the illustration
  - the lifting ring is properly placed
  - the hook is free of any impurities or ice

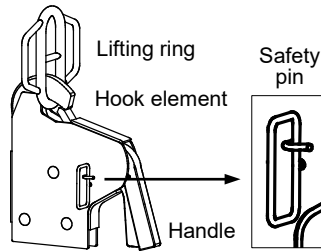

- 2** Start the lowering process with a continuous motion.

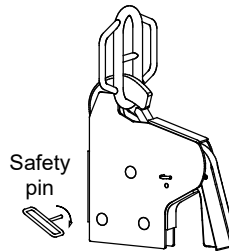

- 3** While the boat is lowered down, twist the safety pin clockwise and pull it out.

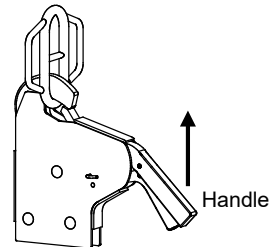

- 4** When the boat is close to the water surface, compress the handle lever and set the handle to the high (activated) position.

Stand back and take a safe stand-by position.

- 5** When the boat gets waterborne and the hook is off-loaded, the hook will open automatically and release the lifting ring.

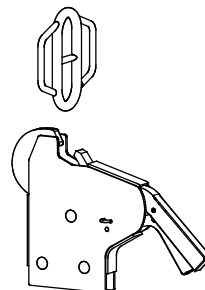

## HMKG

### RESET

- 1 Compress the handle lever and set the handle to the low (closed) position.

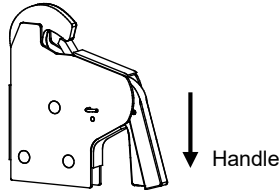

- 2 Insert the safety pin.  
Make sure that the safety pin is properly placed, refer to the illustration.

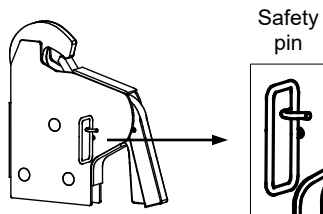

### RECOVERY

- 1 Check visually that the hook is not damaged.  
Make sure that the hook is reset.  
Place the lifting ring properly into the jaw of the hook.

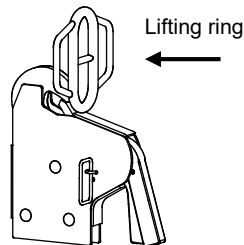

- 2 Make sure that the latch is completely locked, refer to the illustration.  
The hook is ready to recover the boat.

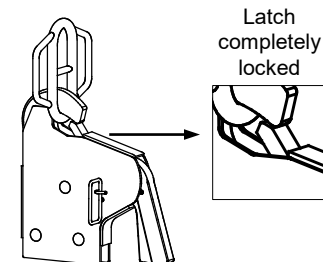

**NOTE:** See the “SAFE USE” chapter at the end of the manual for the recommended lifting operations.

## HMKG

### GENERAL CONSIDERATIONS

- 1 Consider the position of the hook before mounting it on the boat. The hook shall be placed over the center of gravity. The load going through it shall be as straight and symmetrical as possible during the **whole** lifting operation.

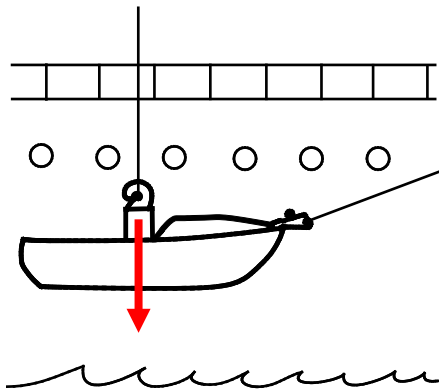

- 2 Make sure that the hook operator can get access to the hook easily, and can operate the hook and connect the lifting ring safely.
- 3 Consider prevention against impurities and icing on the hook.
- 4 We strongly recommend to use standard Henriksen Lifting Rings, because the ring dimensions are designed to **geometrically fit** together with the Henriksen Hooks. See more details in our **HLR** document.
- 5 We offer standard Henriksen Bolt Sets and Shims for mounting. See more details in our **Bolt Set** and **Shims** documents.

## HMKG

- 1** Place the hook between the plates of the lifting arrangement of the boat.

We recommend:

- to use two outside mounting plates if possible
- to apply shims to reduce the gap between the mounting plates and the hook.

Check that the handle points in the preferred direction.

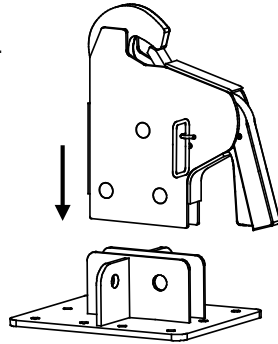

- 2** Insert the mounting bolts through the holes on the lifting arrangement and the hook.

**WARNING:**

Use only recommended bolt, see the table on the next page.

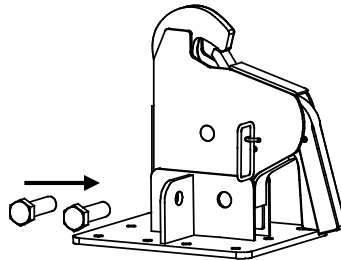

- 3** Mount the locknuts.

We recommend to hold the hook in lifted position when tightening the nuts.

**WARNING:**

Use only recommended locknuts and torques, see the table on the next page.

Always use new locknuts.

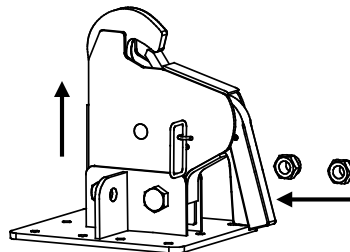

## HMKG

## FUNCTIONAL TEST

Do a functional test of the following after mounting the hook on the boat:

- The handle can be set to high and low positions.
- The hook element can open fully.
- The ring shall be inserted simply and safely.
- The safety pin shall be inserted and pulled out easily.
- The hook is loaded as straight and symmetrical as possible during the **whole** lifting operation.

## RECOMMENDED BOLTS AND LOCKNUTS

Hook type	Bolts and locknuts dimensions (minimum A4 70 quality)		Max. torque (Nm)
	to frame *	to swivel joint	
<b>HMKG 3,5</b>	M24	M24 x 75	70
<b>HMKGD 3,5</b>	M24	M24 x 75	70
<b>HMKG 5</b>	M30	M30 x 90	70
<b>HMKG 8</b>	M30	M30 x 90	70
<b>HMKG 12</b>	M30	M30 x 150	70
<b>HMKG 15</b>	Ø40/M36 **	Ø40/M36 x 75 ***	70

\* The bolt should be unthreaded in the lifting cross-section.

\*\* Stud bolt: shaft Ø40 with M36 threaded ends, EN 1.4462 quality.  
Bolts can be ordered from Henriksen, the length is specified by the boat builder.

\*\*\* Stud bolt: shaft Ø40 with M36 threaded ends, EN 1.4462 quality.  
Shaft length: 75 mm, total length: 163 mm



## HMKG

**1** For safety reasons carry out the control in good lighting conditions.



**2** Remove all impurities (salt, grease, dust, etc.) with fresh water. Remove ice if necessary.



**3** Check that the following parts are free from deformations and defects:

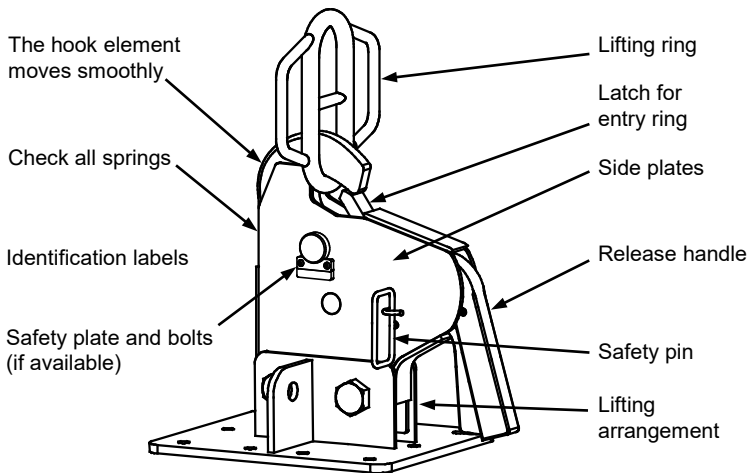

Contact the manufacturer in case of any deviation!



## HMKG

- 4** Do a functional test of the following:
- The handle can be set to high and low positions.
  - The hook element can open fully.
  - The ring shall be inserted simply and safely.
  - The safety pin shall be inserted and pulled out easily.
  - The hook is loaded as straight and symmetrical as possible during the **whole** lifting operation.

**5 DO NOT PAINT ANY PART OF THE HOOK!**



Contact the manufacturer in case of any deviation!



## HMKG

### SAFE LAUNCH

**1** The hook operator connects the lifting ring and the painter line before launch, and then gives a signal to the crane operator that the lowering process can start.

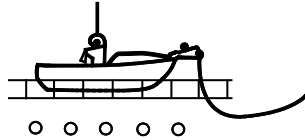

**2** The crane operator starts the lowering process with a continuous motion.

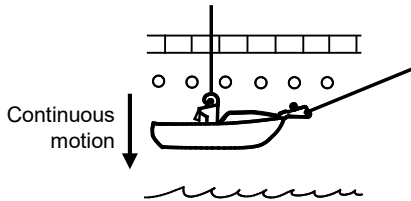

**3** The operators make sure that there are no obstacles under the boat.

The hook operator then activates the lifting hook when the boat is close to the water surface.

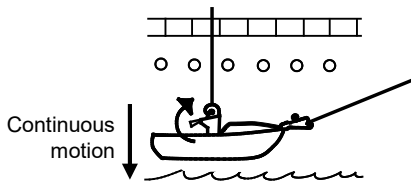

**4** The hook operator stands back and takes a safe stand-by position.

S  
A  
F  
E  
  
U  
S  
E



## HMKG

### SAFE LAUNCH

- 5** When the boat gets waterborne and the lifting hook is off-loaded, the hook will open automatically and release the lifting ring.

The crane operator lifts the lifting ring to avoid collision with the boat or the crew.

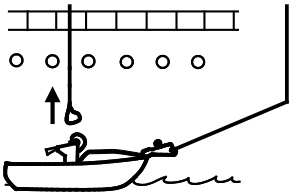

- 6** The coxswain or the hook operator releases the painter line when the boat and the crew is ready.

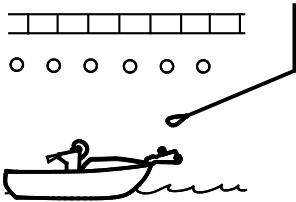

- 7** The coxswain maneuvers the boat ahead and away from the vessel.

S  
A  
F  
E  
  
U  
S  
E



## HMKG

### SAFE RECOVERY

**1** The hook operator makes sure that both the lifting hook and the painter hook are reset.

**2** The coxswain maneuvers the boat close to the vessel to let the hook operator safely get the painter line.

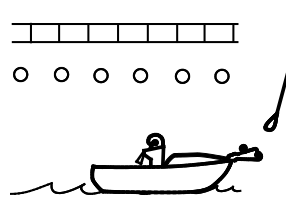

**3** The hook operator connects the painter line. The coxswain aligns the direction of the boat to the vessels direction.

**4** The coxswain reduces the speed of the boat and the painter line is tensioned. The coxswain then makes sure to keep the correct direction of the boat and tension in the painter line.

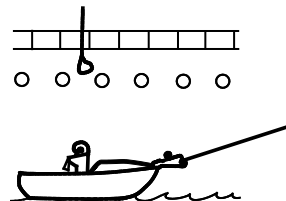

The boat shall then be in the correct position below the lifting ring.

**5** The crane operator lowers the lifting ring to let the hook operator safely get them.

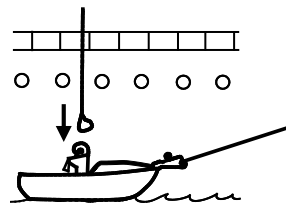

S  
A  
F  
E  
  
U  
S  
E



## HMKG

### SAFE RECOVERY

**6** The hook operator connects the lifting ring, and gives a signal to the crane operator.

The crane operator starts the automatic tensioning system (if available) to give tension in the wire.

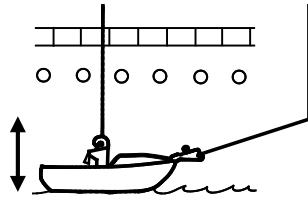

**7** The hook operator stands back and takes a safe stand-by position.

**8** The crane operator starts the lifting process with a smooth motion as the boat moves upwards on a wave.

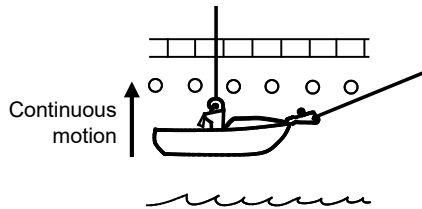

**9** The crane operator completes the lifting process with a continuous motion and places the boat into the crib.

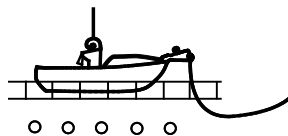

S  
A  
F  
E  
  
U  
S  
E